

FRAME PLATE

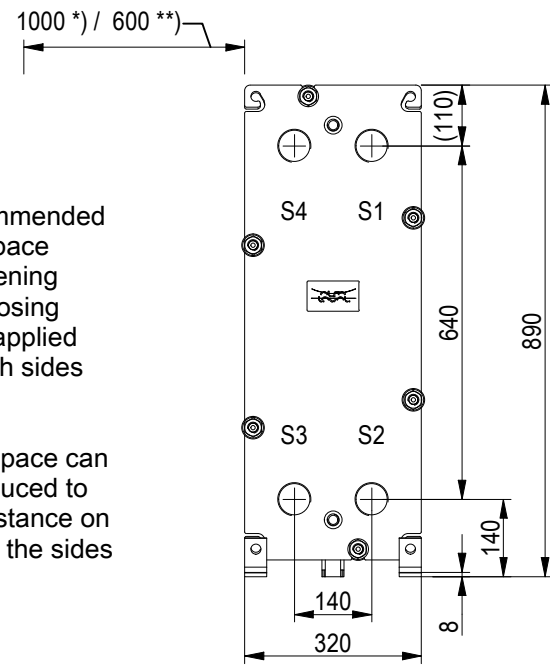

*) Recommended free space for opening and closing to be applied on both sides

**) Free space can be reduced to this distance on one of the sides

Space between pressure plate and supporting column should be kept free from fixed installations!

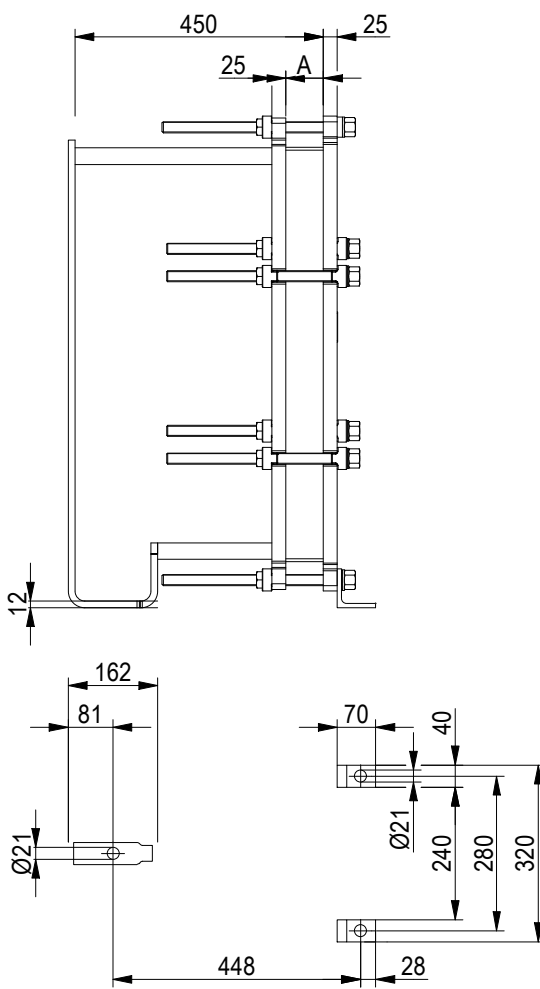

PRESSURE PLATE (MOVABLE)

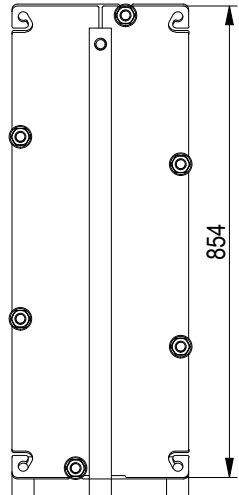

All dimensions in millimeters (mm)

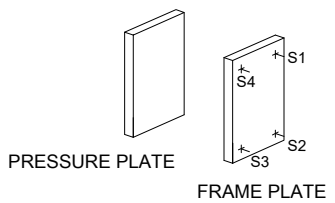
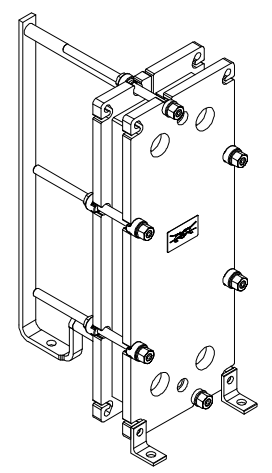

ISO 228 - G 2
S1, S2, S3, S4

A-A:

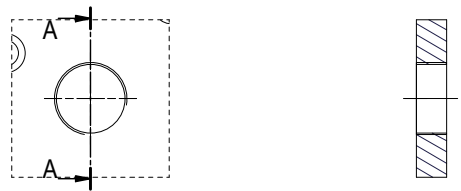

TIGHTENING BOLTS	4 x M20, L = 330 mm	
	2 x M20, L = 330 mm	
A	123 mm	+1%/-1%
APPROX. OUTER DIMENSIONS		
LENGTH	640 mm	
WIDTH	330 mm	
HEIGHT	880 mm	
APPROX. WEIGHTS		
NET WEIGHT, EMPTY	146 kg	
WEIGHT FULL OF WATER	160 kg	
PLATE MATERIAL	ALLOY 316	
PLATE THICKNESS	0.5 mm	
GASKET	NBRP ClipGrip™	

NO. OF UNITS 1



DRAWING
GASKETED PLATE HEAT EXCHANGER
T6-PFG
PED Article 4.3

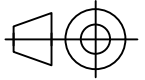

ECOSTAR SRL

Do not use this drawing for foundation bolting or piping layout

DATE 20/06/22
REVISION 0

This document and its contents are subject to copyrights and other intellectual property rights owned by Alfa Laval (pub) or any of its affiliates (Alfa Laval). No part of this document may be copied, reproduced or transmitted in any form or by any means, or for any purpose, without Alfa Laval's prior express written permission. Information and services provided in this document are made as a benefit and service to the user, and no representations or warranties are made about the accuracy or suitability of this information and these services for any purpose. All rights are reserved.